



Door coupling rotary handle, lockable, size 2

Part no. **NZM2-XTVD**
 Catalog No. **260168**

EL-Nummer **0004358774**
 (Norway)

Similar to illustration

Delivery program

Product range		Accessories
Accessories		Door coupling rotary handle
Standard/Approval		UL/CSA, IEC
Construction size		NZM2
Description		Door coupling rotary handle for operating the switch through a closed control panel door
Function		Standard, black/grey
Protection class		IP66 UL/CSA Type 4X, Type 12
Locking facility		lockable on the 0 position on the handle using up to 3 padlocks With door interlock
Door interlock		Not defeated in the locked OFF and ON positions Can be modified in the unlocked ON position Can be modified such that it can be defeated from the outside using a screwdriver Door can be opened in OFF
Project planning information		External warning plate/designation label can be clipped on. Complete including rotary drive and coupling parts Extension shaft additionally required.
For use with		NZM2(-4), PN2(-4), N(S)2(-4)
lockable		single

Notes

Circuit-breaker can also be installed in a lying position 90 ° left/right, with the handle still in the same position.

Design verification as per IEC/EN 61439

IEC/EN 61439 design verification		
10.2 Strength of materials and parts		
10.2.2 Corrosion resistance		Meets the product standard's requirements.
10.2.3.1 Verification of thermal stability of enclosures		Meets the product standard's requirements.
10.2.3.2 Verification of resistance of insulating materials to normal heat		Meets the product standard's requirements.
10.2.3.3 Verification of resistance of insulating materials to abnormal heat and fire due to internal electric effects		Meets the product standard's requirements.
10.2.4 Resistance to ultra-violet (UV) radiation		Meets the product standard's requirements.
10.2.5 Lifting		Does not apply, since the entire switchgear needs to be evaluated.
10.2.6 Mechanical impact		Does not apply, since the entire switchgear needs to be evaluated.
10.2.7 Inscriptions		Meets the product standard's requirements.
10.3 Degree of protection of ASSEMBLIES		Does not apply, since the entire switchgear needs to be evaluated.
10.4 Clearances and creepage distances		Meets the product standard's requirements.
10.5 Protection against electric shock		Does not apply, since the entire switchgear needs to be evaluated.
10.6 Incorporation of switching devices and components		Does not apply, since the entire switchgear needs to be evaluated.
10.7 Internal electrical circuits and connections		Is the panel builder's responsibility.
10.8 Connections for external conductors		Is the panel builder's responsibility.
10.9 Insulation properties		
10.9.2 Power-frequency electric strength		Is the panel builder's responsibility.
10.9.3 Impulse withstand voltage		Is the panel builder's responsibility.
10.9.4 Testing of enclosures made of insulating material		Is the panel builder's responsibility.
10.10 Temperature rise		The panel builder is responsible for the temperature rise calculation. Eaton will provide heat dissipation data for the devices.
10.11 Short-circuit rating		Is the panel builder's responsibility. The specifications for the switchgear must be observed.

10.12 Electromagnetic compatibility		Is the panel builder's responsibility. The specifications for the switchgear must be observed.
10.13 Mechanical function		The device meets the requirements, provided the information in the instruction leaflet (IL) is observed.

Technical data ETIM 7.0

Low-voltage industrial components (EG000017) / Handle for power circuit breaker (EC000229)

Electric engineering, automation, process control engineering / Low-voltage switch technology / Circuit breaker (LV < 1 kV) / Handle for switch devices (ecl@ss10.0.1-27-37-04-14 [AKF012014])

Lockable		Yes
Colour		Black
Suitable for emergency stop		No
With extension shaft		No
Suitable for power circuit breaker		Yes
Suitable for switch disconnecter		Yes

Approvals

Product Standards		UL489; CSA-C22.2 No. 5-09; IEC60947, CE marking
UL File No.		E140305
UL Category Control No.		DIHS
CSA File No.		022086
CSA Class No.		1437-01
North America Certification		UL listed, CSA certified
Degree of Protection		IEC: IP66, UL/CSA Type 4X, 12

Dimensions

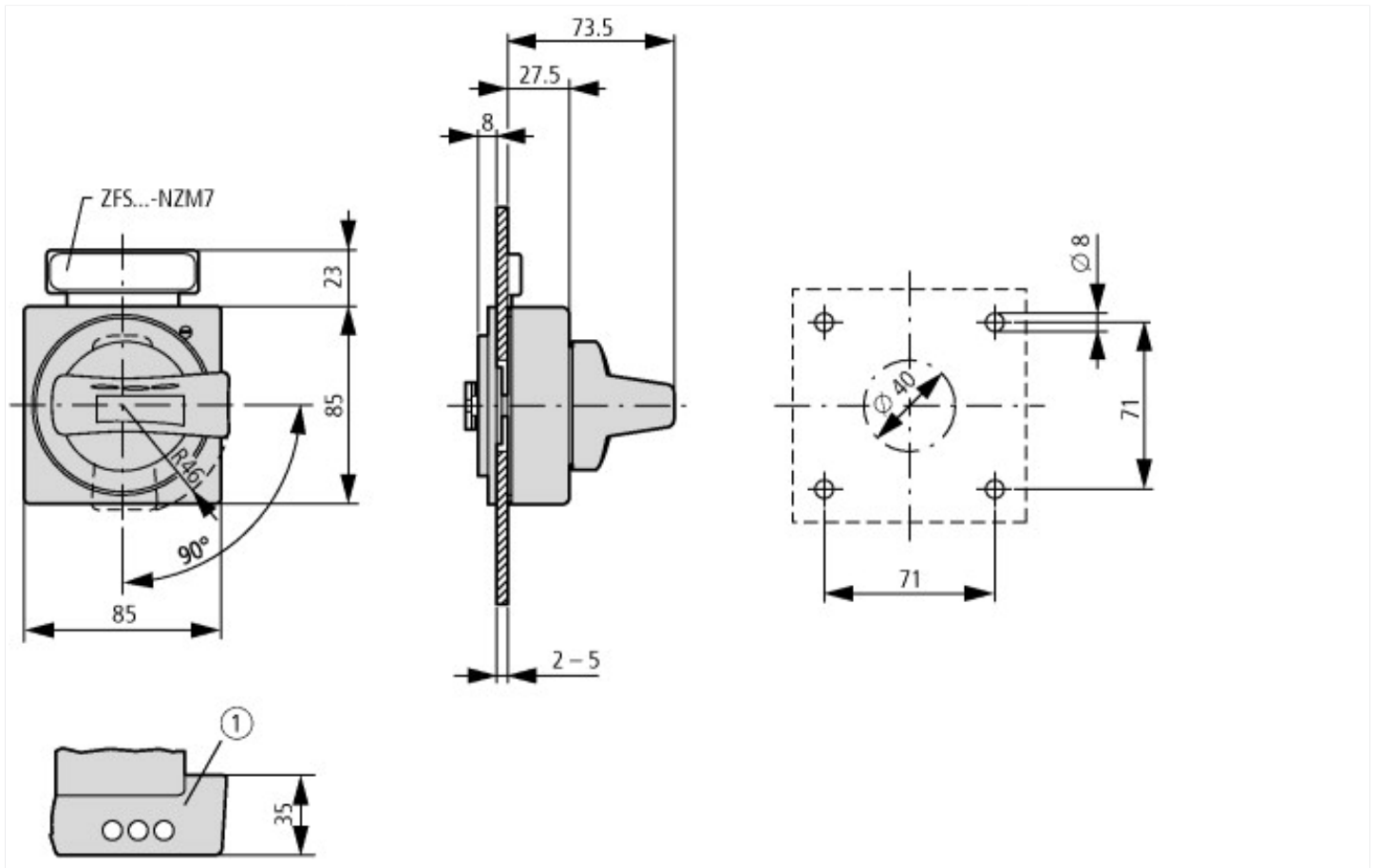

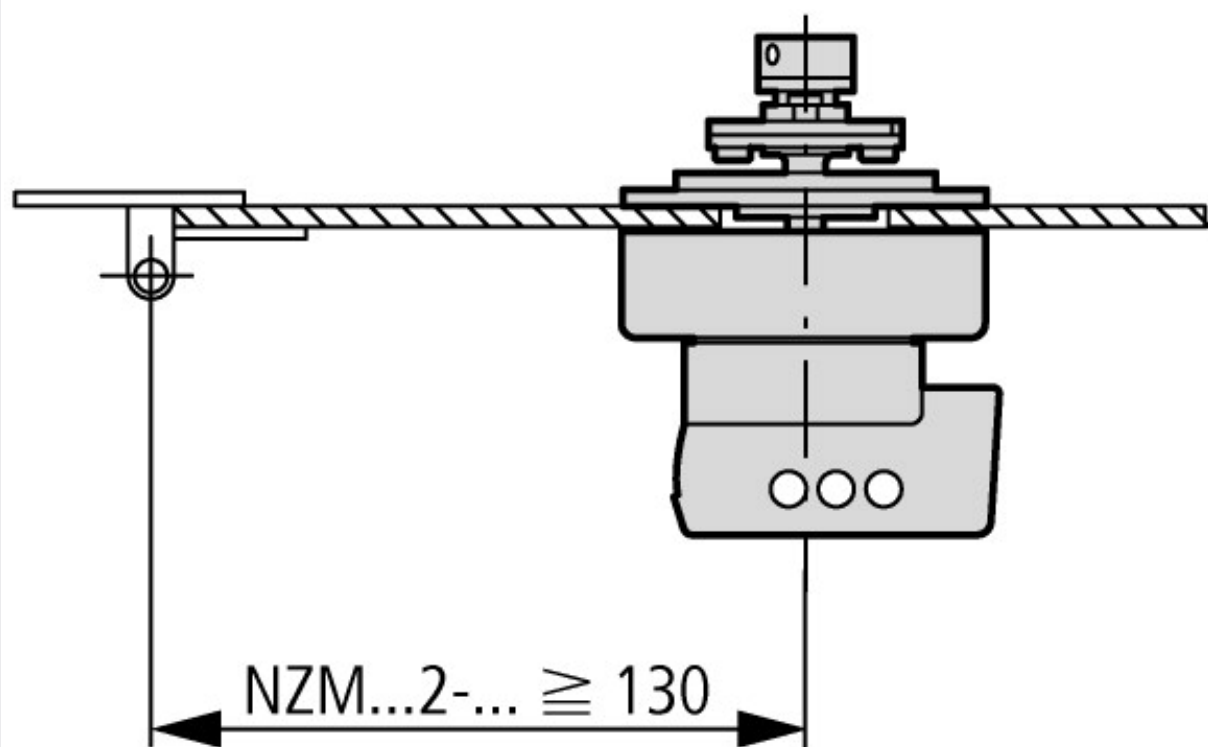
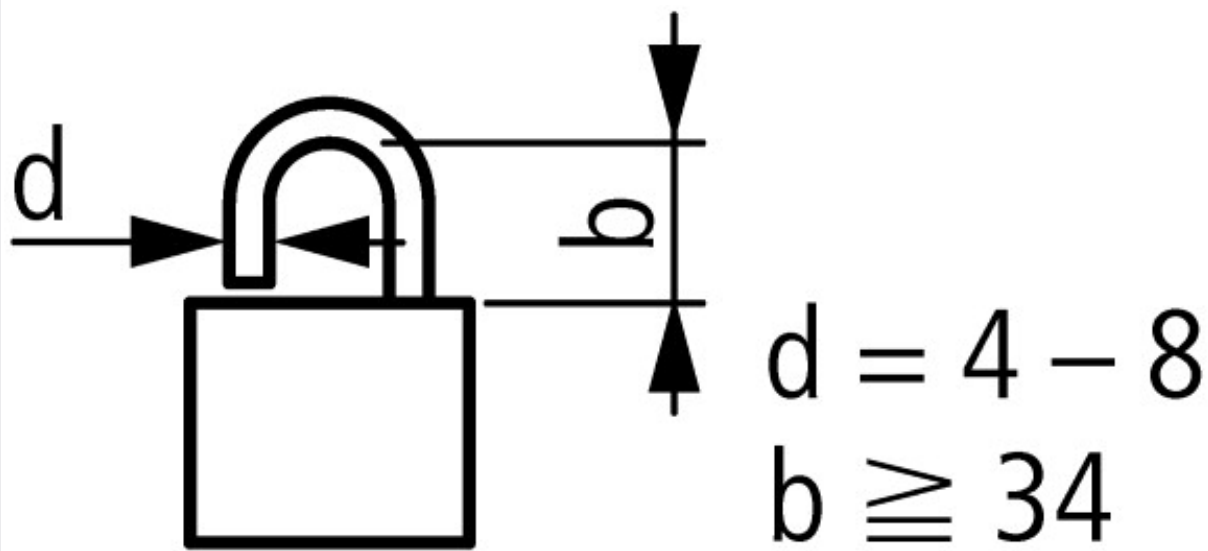

Minimum door coupling rotary handle clearance from door pivot point

Additional product information (links)

IL01203005Z (AWA1230-1998) Door coupling rotary handle

IL01203005Z (AWA1230-1998) Door coupling rotary handle ftp://ftp.moeller.net/DOCUMENTATION/AWA_INSTRUCTIONS/IL01203005Z2019_03.pdf